

LazerLine WET

High Efficiency Linear Outdoor



Select options next to clock symbol to qualify your order.

QuickShip max order = 25 pcs



FEATURES

- Up to 45,201 cd
- Up to 1100 lm/ft and 100 LPW
- Several Optics for every application
- Multiple Outputs included ASHRAE Compliant
- Slim Form Factor with 90° Adjustable Bracket(s) Standard
- Unique Push locking waterproof connector system, IP68 rated
- 0-10V Dimmable, 1% Standard

PERFORMANCE

Beam Spread: 9° (Native Optic), 10°x30°, 10°x60°, 15°x25°, 30°, 30°x14°, 30°x60°, 50°x80°, 80°
CCT Options: 2700K, 3000K, 3500K, 4000K, 5000K
CRI: 83 CRI
Consistency: 2 SDCM (Luminaire to Luminaire)
Lumens: 1100 lm/ft (nominal)
Lumen Maintenance: L70 >70,000 hours



PHYSICAL

Mounting: Adjustable Bracket (90°), other options available
Housing: Extruded aluminum housing with injection molded end caps
Finish: Anodized Aluminum, Powder Coated Endcaps
Warranty: 5-Year limited warranty
Lens: IK08 impact compliant, Low iron tempered glass
Ingress Protection: IP66 wet, exterior location (Connectors IP68)
Vibration Resistance: Compliant with 3G ANSI C136.31
Weight: 1.3 lbs/ft
Operating Temperature: -4°F to 104°F (-20°C to 40°C)

ELECTRICAL

Voltage: Universal 120 - 277 VAC
Power Supply: Integral Class II, electronic high-power factor >0.94 @120V
Power Consumption: Maximum 12W/ft
Dimming: LD 0-10V Dimming, 1% (Standard)
Certification: ETL / cETL wet location listed
Standards: cETLus Listed, CE, NOM

PHYSICAL DIMENSIONS

| Model | Length (A) |
|---------|------------|
| LZWET-1 | 12.3 inch |
| LZWET-4 | 48 inch |

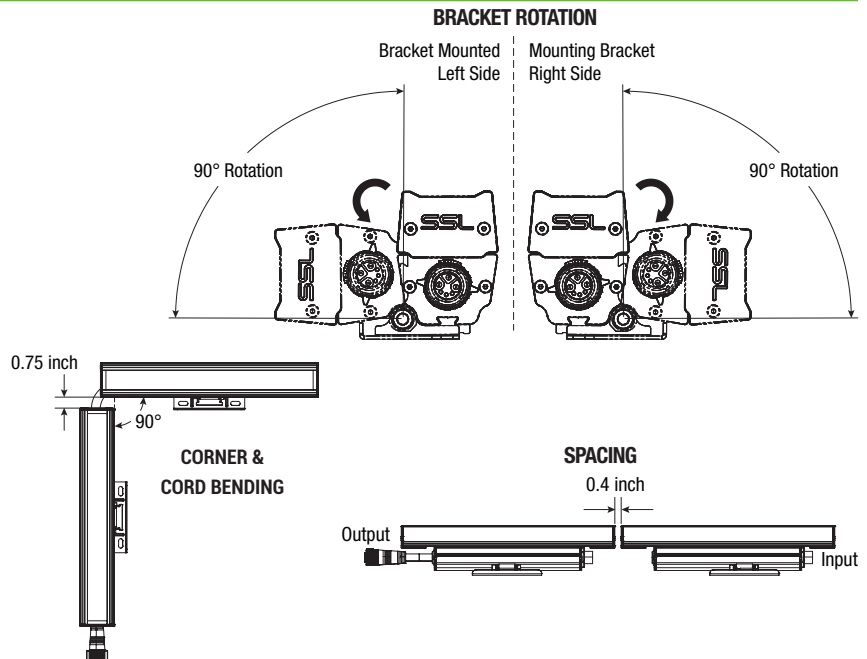
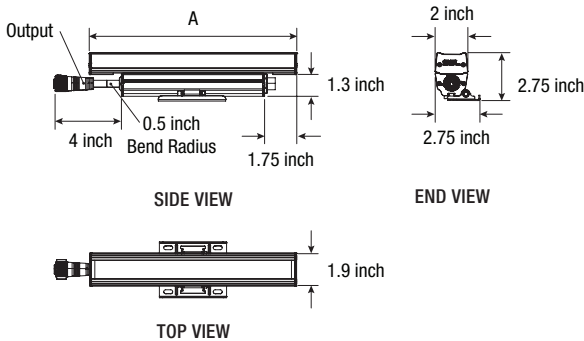

Date: _____

Type: _____

Fixture: _____

Project: _____

Approved:

LazerLine WET

PRODUCT CODE

EXAMPLE: LZWET-1-UNV-827-11L-9-LD

QuickShip max order = 25 pcs

Select options next to clock symbol to qualify your order.

| MODEL | LENGTH | VOLTAGE | COLOR | LUMENS | OPTICS | DIMMING | OPTIONS |
|---|--------|---------|-------|---|--------|---|---------|
| LZWET | | UNV | | | | LD | |
| MODEL | | | | LUMENS nominal | | DIMMING | |
| <input checked="" type="checkbox"/> LZWET | | | | 1 FT | | <input checked="" type="checkbox"/> LD 0-10V Dimming, 1% (Standard) | |
| LENGTH | | | | <input checked="" type="checkbox"/> 11L 1100 lm (12W) 1100 lm/ft | | | |
| <input checked="" type="checkbox"/> 1 12.3 in | | | | <input checked="" type="checkbox"/> 08L 750 lm (9.5W) 750 lm/ft | | | |
| <input checked="" type="checkbox"/> 4 48 in | | | | <input checked="" type="checkbox"/> 04L 400 lm (5W) 400 lm/ft* | | | |
| VOLTAGE | | | | 4 FT | | | |
| <input checked="" type="checkbox"/> UNV Universal 120 - 277 VAC | | | | <input checked="" type="checkbox"/> 44L 4400 lm (44W) 1100 lm/ft | | | |
| | | | | <input checked="" type="checkbox"/> 30L 3000 lm (33W) 750 lm/ft | | | |
| | | | | <input checked="" type="checkbox"/> 16L 1600 lm (20W) 400 lm/ft* | | | |
| | | | | *ASHRAE Compliant | | | |
| CCT | | | | OPTICS nominal | | | |
| <input checked="" type="checkbox"/> 827 (83CRI) 2700K | | | | <input checked="" type="checkbox"/> 9 9° x 9° Beam (Native Optic) | | | |
| <input checked="" type="checkbox"/> 830 (83CRI) 3000K | | | | <input checked="" type="checkbox"/> 1030 10° x 30° Beam | | | |
| <input checked="" type="checkbox"/> 835 (83CRI) 3500K | | | | <input checked="" type="checkbox"/> 1060 10° x 60° Beam | | | |
| <input checked="" type="checkbox"/> 840 (83CRI) 4000K | | | | <input checked="" type="checkbox"/> 1525 15° x 25° Beam | | | |
| <input checked="" type="checkbox"/> 850 (83CRI) 5000K | | | | <input checked="" type="checkbox"/> 30 30° x 30° Beam | | | |
| | | | | <input checked="" type="checkbox"/> 3060 30° x 60° Beam | | | |
| | | | | <input checked="" type="checkbox"/> 5080 50° x 80° Beam | | | |
| | | | | <input checked="" type="checkbox"/> 80 80° x 80° Beam | | | |

(Order separately. Indicate the quantity needed for each item.) (See Page 9 for Maximum Run Lengths)
 (REQUIRED: Starter Connection Cord (SC05LZWET/ SC10LZWET) and Standard Terminator Cap (TCAPLZWET) for every run.)
 NOTE: 10°x60°, 30°x60°, 50°x80° and 80°x80° optical options not recommended for louver options.

ACCESSORIES

- SC05LZWET 5 ft. Starter Connection Cord
- EC24LZWET 24 in. Extension Cord
- LLZWL-1 LZWET Louver*
- SC10LZWET 10 ft. Starter Connection Cord
- EC60LZWET 60 in. Extension Cord
- LLZWS-1 LZWET Louver w/ House Shield*
- TCAPLZWET Standard Terminator Cap
- *One Louver per linear foot (Either LLZWL-1 or LLZWS-1)
Each LZWET-1 requires 1 louver, Each LZWET-4 requires 4 louvers

MOUNTING ACCESSORIES

(Order separately.) (ADBW3 Bracket(s) Included with Luminaire.) (Requirements vary for each luminaire ordered. See mounting pages for details.)

- CA3-6 Cantilever Arm - 6"
- LS-6 Landscape Spike - 6"
- CA3-12 Cantilever Arm - 12"
- HLS Heavy Duty Landscape Spike
- CA3-18 Cantilever Arm - 18"

LazerLine WET

LUMENS / WATTAGE nominal

| Model | Watts | LM79 Test Result @ Max Lumens |
|---------|-------|-----------------------------------|
| | | 840 (4000 Kelvin, CRI 83) Nominal |
| LZWET-1 | 5W | 400 lm/ft |
| | 9.5W | 750 lm/ft |
| | 12W | 1100 lm/ft |
| LZWET-4 | 20W | 400 lm/ft |
| | 33W | 750 lm/ft |
| | 44W | 1100 lm/ft |

| CCT Multiplier (CRI83) | |
|------------------------|------------|
| CCT | Multiplier |
| 827 (2700K) | 0.96 |
| 830 (3000K) | 0.98 |
| 835 (3500K) | 1.00 |
| 840 (4000K) | 1.00 |
| 850 (5000K) | 1.04 |

PHOTOMETRICS

LZWET-1-UNV-840-11L-9-LD.ies

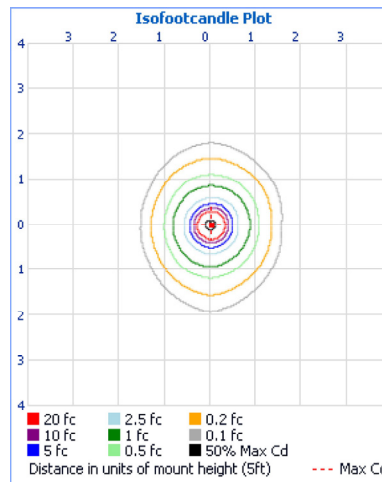
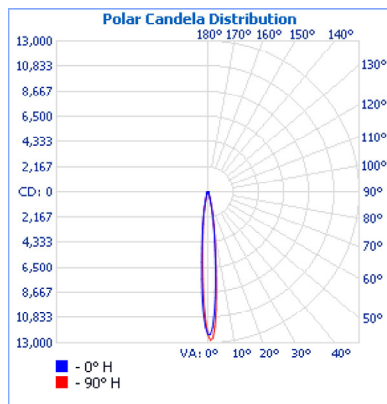

Zonal Lumen Summary

| Zone | Lumens | % Lamp | % Luminaire |
|-------|--------|--------|-------------|
| 0-30 | 872.2 | 90.9% | 87.2% |
| 0-40 | 923.0 | 96.2% | 92.3% |
| 0-60 | 981.4 | 102.3% | 98.2% |
| 60-90 | 18.4 | 1.9% | 1.8% |
| 0-90 | 999.8 | 104.2% | 100% |

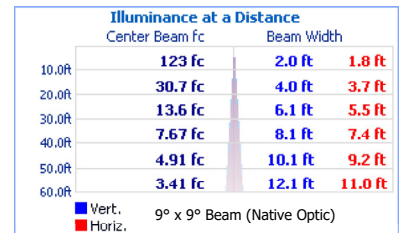

LZWET-1-UNV-840-11L-1030-LD.ies

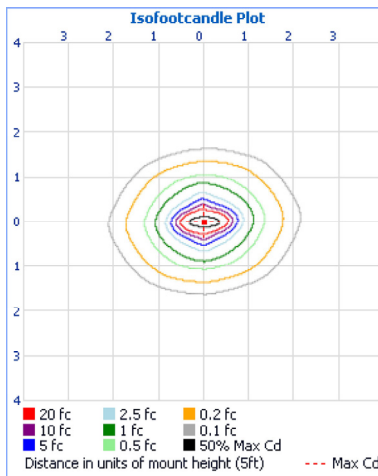
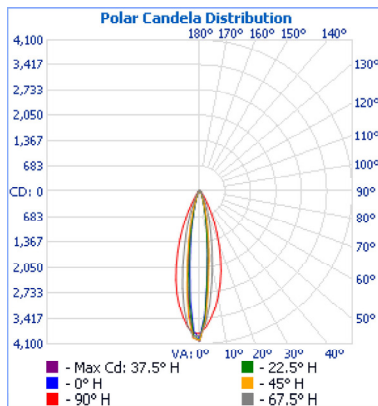

Zonal Lumen Summary

| Zone | Lumens | % Luminaire |
|--------|--------|-------------|
| 0-30 | 742.4 | 78.8% |
| 0-40 | 826.4 | 87.7% |
| 0-60 | 903.1 | 95.9% |
| 60-90 | 31.1 | 3.3% |
| 70-100 | 13.3 | 1.4% |
| 90-120 | 3.0 | 0.3% |
| 0-90 | 934.2 | 99.2% |
| 90-180 | 7.7 | 0.8% |
| 0-180 | 941.9 | 100% |

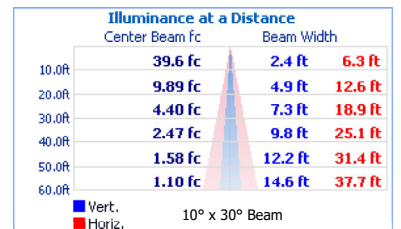

LazerLine WET

PHOTOMETRICS

LZWET-1-UNV-840-11L-1060-LD.ies

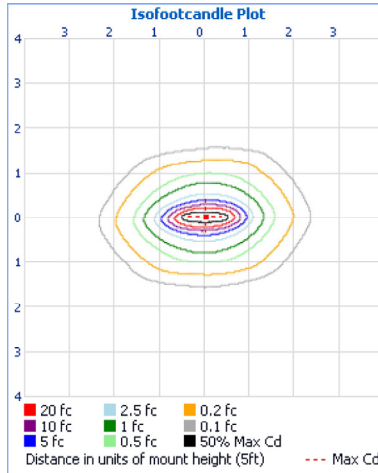
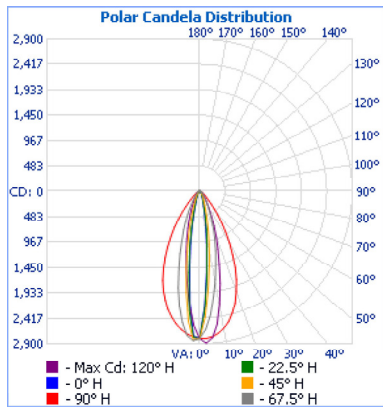

Zonal Lumen Summary

| Zone | Lumens | % Luminaire |
|--------|--------|-------------|
| 0-30 | 670.0 | 71% |
| 0-40 | 795.7 | 84.3% |
| 0-60 | 901.7 | 95.6% |
| 60-90 | 36.7 | 3.9% |
| 70-100 | 14.8 | 1.6% |
| 90-120 | 1.7 | 0.2% |
| 0-90 | 938.4 | 99.5% |
| 90-180 | 5.1 | 0.5% |
| 0-180 | 943.4 | 100% |

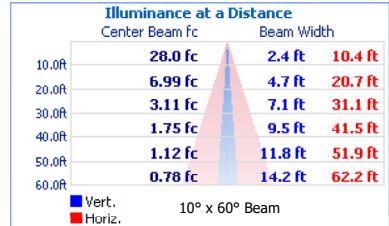

LZWET-1-UNV-840-11L-1525-LD.ies

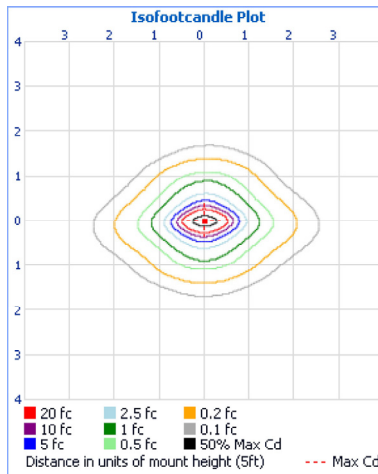
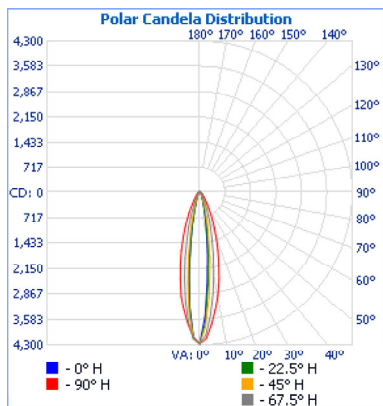

Zonal Lumen Summary

| Zone | Lumens | % Luminaire |
|--------|--------|-------------|
| 0-30 | 713.5 | 76.5% |
| 0-40 | 796.5 | 85.4% |
| 0-60 | 881.7 | 94.5% |
| 60-90 | 42.5 | 4.5% |
| 70-100 | 21.0 | 2.2% |
| 90-120 | 3.9 | 0.4% |
| 0-90 | 924.1 | 99% |
| 90-180 | 9.0 | 1% |
| 0-180 | 933.1 | 100% |

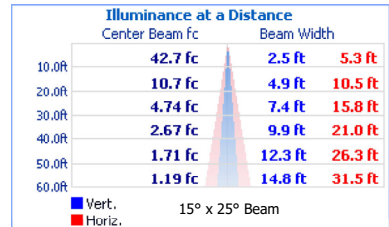

LZWET-1-UNV-840-11L-30-LD.ies

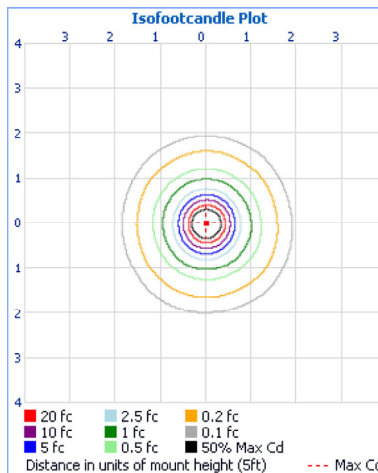
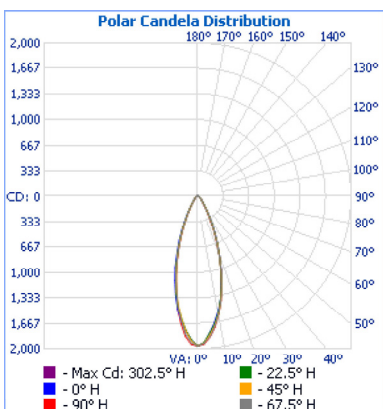

Zonal Lumen Summary

| Zone | Lumens | % Luminaire |
|--------|--------|-------------|
| 0-30 | 705.4 | 74.9% |
| 0-40 | 810.1 | 86% |
| 0-60 | 898.7 | 95.4% |
| 60-90 | 36.3 | 3.9% |
| 70-100 | 15.1 | 1.6% |
| 90-120 | 2.8 | 0.3% |
| 0-90 | 935.0 | 99.2% |
| 90-180 | 7.3 | 0.8% |
| 0-180 | 942.3 | 100% |

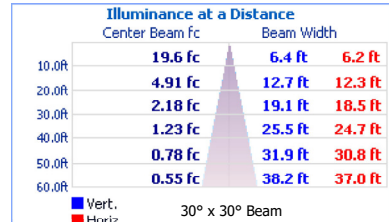

LazerLine WET

PHOTOMETRICS

LZWET-1-UNV-840-11L-3060-LD.ies

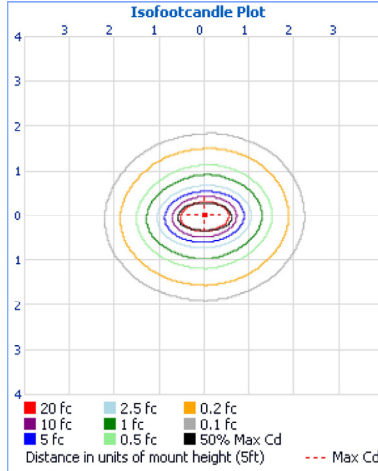
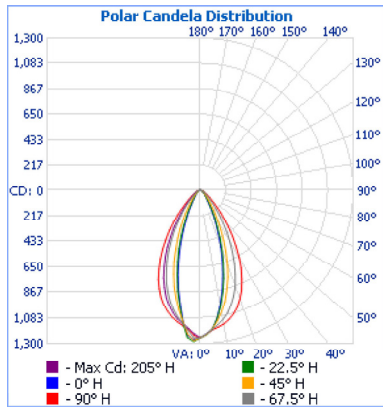

Zonal Lumen Summary

| Zone | Lumens | % Luminaire |
|--------|--------|-------------|
| 0-30 | 597.5 | 63.8% |
| 0-40 | 754.6 | 80.5% |
| 0-60 | 886.0 | 94.5% |
| 60-90 | 43.9 | 4.7% |
| 70-100 | 17.5 | 1.9% |
| 90-120 | 2.8 | 0.3% |
| 0-90 | 930.0 | 99.2% |
| 90-180 | 7.2 | 0.8% |
| 0-180 | 937.2 | 100% |

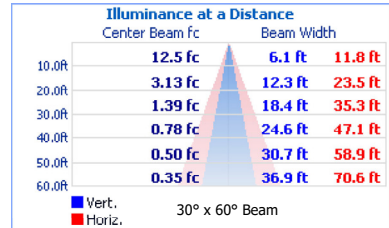

LZWET-1-UNV-840-11L-5080-LD.ies

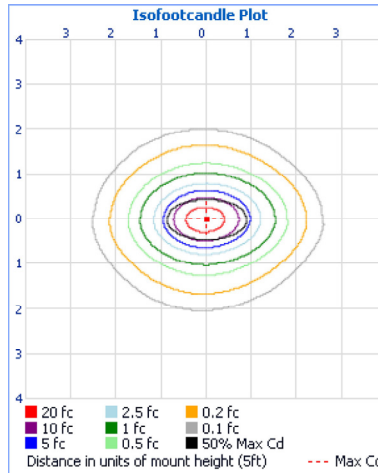
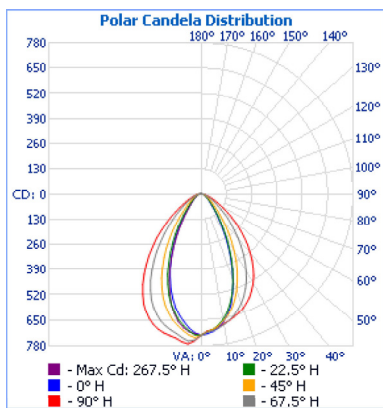

Zonal Lumen Summary

| Zone | Lumens | % Luminaire |
|--------|--------|-------------|
| 0-30 | 461.6 | 50.1% |
| 0-40 | 648.8 | 70.4% |
| 0-60 | 848.3 | 92.1% |
| 60-90 | 64.5 | 7% |
| 70-100 | 24.8 | 2.7% |
| 90-120 | 3.4 | 0.4% |
| 0-90 | 912.8 | 99.1% |
| 90-180 | 8.3 | 0.9% |
| 0-180 | 921.1 | 100% |

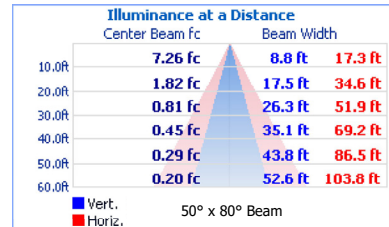

LZWET-1-UNV-840-11L-80-LD.ies

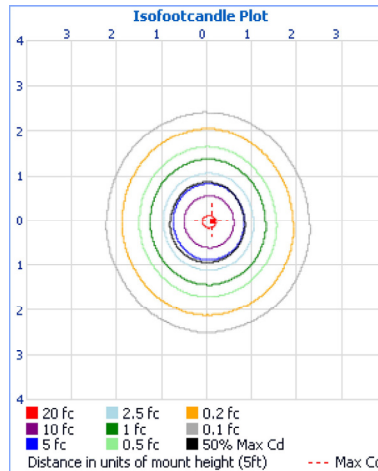
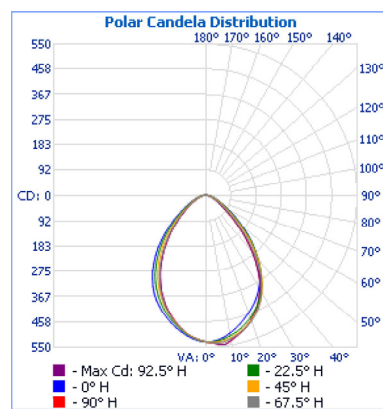

Zonal Lumen Summary

| Zone | Lumens | % Luminaire |
|--------|--------|-------------|
| 0-30 | 377.1 | 41.6% |
| 0-40 | 576.8 | 63.6% |
| 0-60 | 827.4 | 91.2% |
| 60-90 | 75.2 | 8.3% |
| 70-100 | 26.6 | 2.9% |
| 90-120 | 1.6 | 0.2% |
| 0-90 | 902.7 | 99.5% |
| 90-180 | 4.6 | 0.5% |
| 0-180 | 907.3 | 100% |

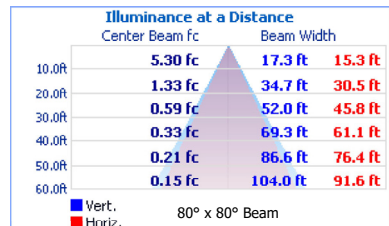

LazerLine WET

PHOTOMETRICS

LZWET-4-UNV-840-44L-1030-LD.ies

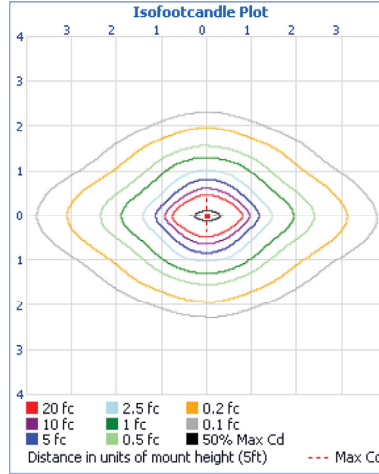
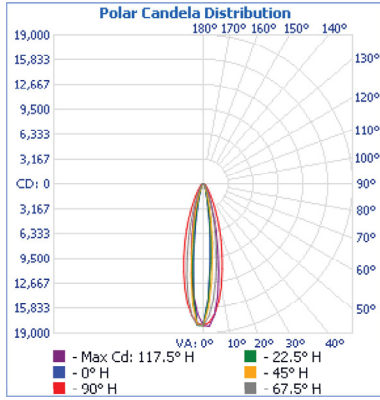

Zonal Lumen Summary

| Zone | Lumens | % Luminaire |
|--------|---------|-------------|
| 0-30 | 3,111.3 | 78.2% |
| 0-40 | 3,465.9 | 87.2% |
| 0-60 | 3,811.7 | 95.9% |
| 60-90 | 151.3 | 3.8% |
| 70-100 | 67.1 | 1.7% |
| 90-120 | 3.0 | 0.1% |
| 0-90 | 3,963.0 | 99.7% |
| 90-180 | 13.3 | 0.3% |
| 0-180 | 3,976.3 | 100% |

Illuminance at a Distance

| | Center Beam fc | Beam Width |
|-------|----------------|-----------------|
| 10.0R | 180 fc | 2.4 ft 5.6 ft |
| 20.0R | 45.1 fc | 4.9 ft 11.1 ft |
| 30.0R | 20.0 fc | 7.3 ft 16.7 ft |
| 40.0R | 11.3 fc | 9.7 ft 22.2 ft |
| 50.0R | 7.21 fc | 12.1 ft 27.8 ft |
| 60.0R | 5.01 fc | 14.6 ft 33.3 ft |

10° x 30° Beam

LZWET-4-UNV-840-44L-1060-LD.ies

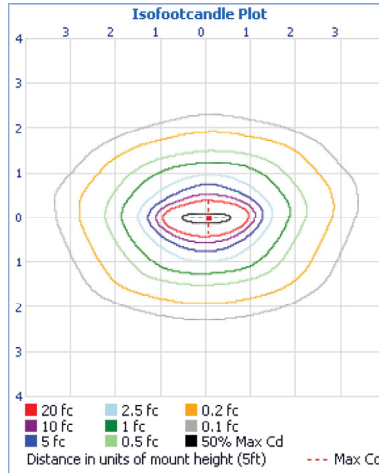
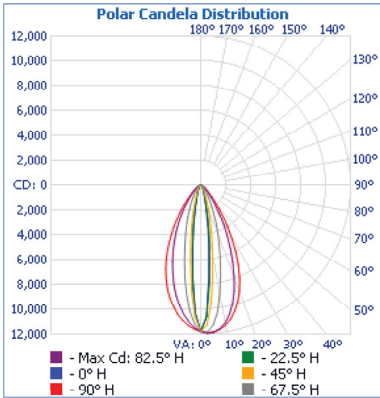

Zonal Lumen Summary

| Zone | Lumens | % Luminaire |
|--------|---------|-------------|
| 0-30 | 2,764.6 | 70.7% |
| 0-40 | 3,288.7 | 84.1% |
| 0-60 | 3,735.8 | 95.5% |
| 60-90 | 158.2 | 4% |
| 70-100 | 65.8 | 1.7% |
| 90-120 | 7.9 | 0.2% |
| 0-90 | 3,894.0 | 99.6% |
| 90-180 | 17.3 | 0.4% |
| 0-180 | 3,911.3 | 100% |

Illuminance at a Distance

| | Center Beam fc | Beam Width |
|-------|----------------|-----------------|
| 10.0R | 118 fc | 2.3 ft 10.3 ft |
| 20.0R | 29.5 fc | 4.5 ft 20.7 ft |
| 30.0R | 13.1 fc | 6.8 ft 31.0 ft |
| 40.0R | 7.37 fc | 9.1 ft 41.4 ft |
| 50.0R | 4.71 fc | 11.3 ft 51.7 ft |
| 60.0R | 3.27 fc | 13.6 ft 62.0 ft |

10° x 60° Beam

LZWET-4-UNV-840-44L-30-LD.ies

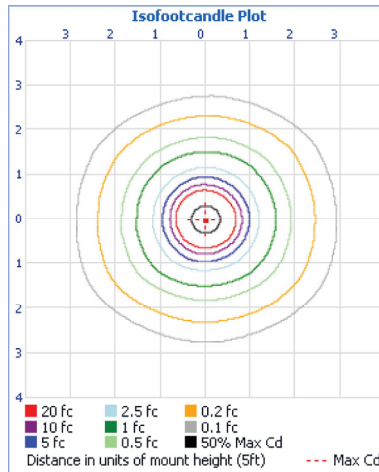
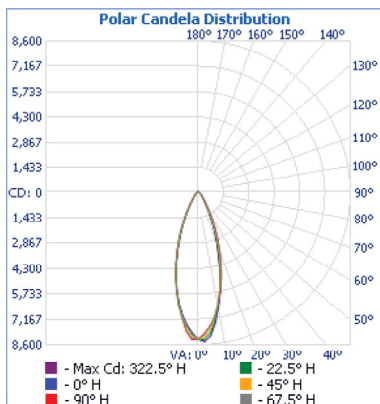

Zonal Lumen Summary

| Zone | Lumens | % Luminaire |
|--------|---------|-------------|
| 0-30 | 3,014.1 | 74.5% |
| 0-40 | 3,475.7 | 85.9% |
| 0-60 | 3,867.4 | 95.6% |
| 60-90 | 163.5 | 4% |
| 70-100 | 66.2 | 1.6% |
| 90-120 | 5.1 | 0.1% |
| 0-90 | 4,030.9 | 99.6% |
| 90-180 | 15.8 | 0.4% |
| 0-180 | 4,046.7 | 100% |

Illuminance at a Distance

| | Center Beam fc | Beam Width |
|-------|----------------|-----------------|
| 10.0R | 82.8 fc | 6.1 ft 6.3 ft |
| 20.0R | 20.7 fc | 12.2 ft 12.5 ft |
| 30.0R | 9.20 fc | 18.4 ft 18.8 ft |
| 40.0R | 5.17 fc | 24.5 ft 25.1 ft |
| 50.0R | 3.31 fc | 30.6 ft 31.3 ft |
| 60.0R | 2.30 fc | 36.7 ft 37.6 ft |

30° x 30° Beam

LazerLine WET

PHOTOMETRICS

LZWET-4-UNV-840-44L-3060-LD.ies

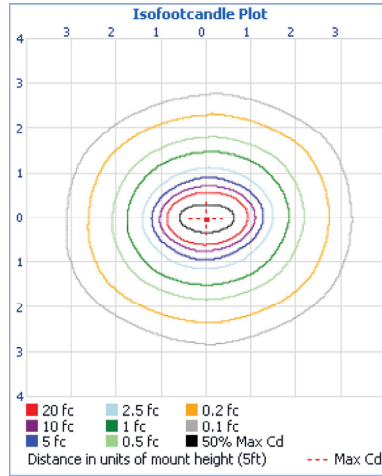
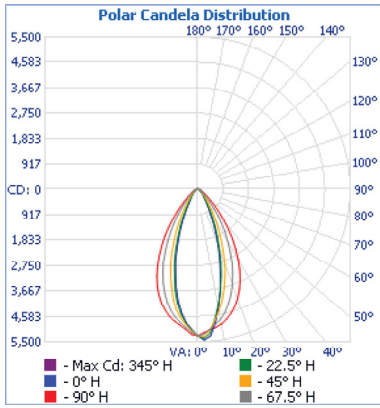

Zonal Lumen Summary

| Zone | Lumens | % Luminaire |
|--------|---------|-------------|
| 0-30 | 2,551.4 | 63.2% |
| 0-40 | 3,232.7 | 80% |
| 0-60 | 3,812.7 | 94.4% |
| 60-90 | 203.4 | 5% |
| 70-100 | 86.3 | 2.1% |
| 90-120 | 11.8 | 0.3% |
| 0-90 | 4,016.1 | 99.4% |
| 90-180 | 22.3 | 0.6% |
| 0-180 | 4,038.5 | 100% |

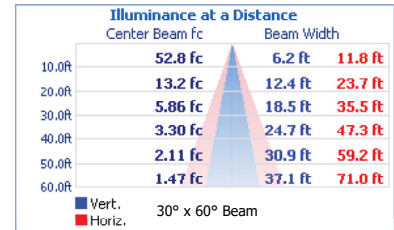

LazerLine WET

ACCESSORIES

| LOUVER — LLZW-1 | | |
|-----------------|-------------|----------------|
| Luminaire | Part Number | Stacked Length |
| 1 FT | 1x LLZW-1 | 11.8 inch |
| 4 FT | 4x LLZW-1 | 47.2 inch |

| LOUVER HOUSE SHIELD — LLZWHS-1 | | |
|--------------------------------|-------------|----------------|
| Luminaire | Part Number | Stacked Length |
| 1 FT | 1x LLZWHS-1 | 11.8 inch |
| 4 FT | 4x LLZWHS-1 | 47.2 inch |

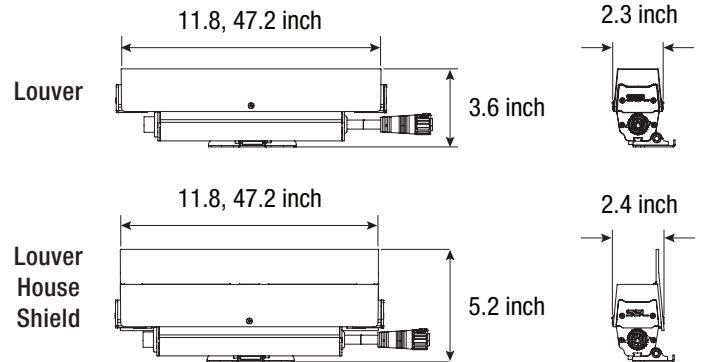

| MAXIMUM RUN LENGTHS | | | |
|---------------------|------|-------------------|-------------------|
| Model | W/FT | Input Voltage | |
| | | 120 VAC, 50/60 Hz | 277 VAC, 50/60 Hz |
| LZWET | 12W | 52 | 128 |
| | 9.5W | 70 | 132 |
| | 5W | 70 | 132 |

| CONNECTIONS & CABLES | |
|----------------------|-------------------------------|
| Model | Description |
| SC05LZWET | 5 FT Starter Connection Cord |
| SC10LZWET | 10 FT Starter Connection Cord |
| TCAPLZWET | Standard Terminator Cap |
| EC24LZWET | 24 inch Extension Cord |
| EC60LZWET | 60 inch Extension Cord |

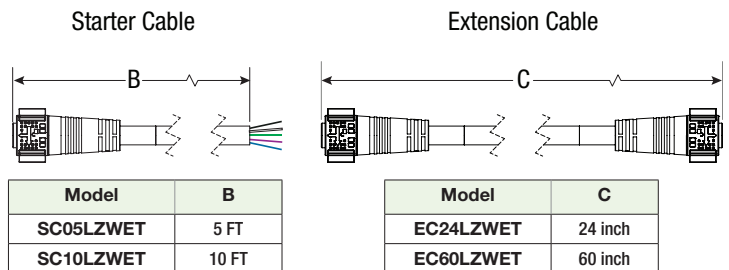

LazerLine WET

MOUNTING ACCESSORIES

| STANDARD ADJUSTABLE BRACKET — ADBW3 (90°) | |
|---|---------------------------|
| Luminaire | Minimum Required Quantity |
| 1 FT | 1 |
| 4 FT | 2 |

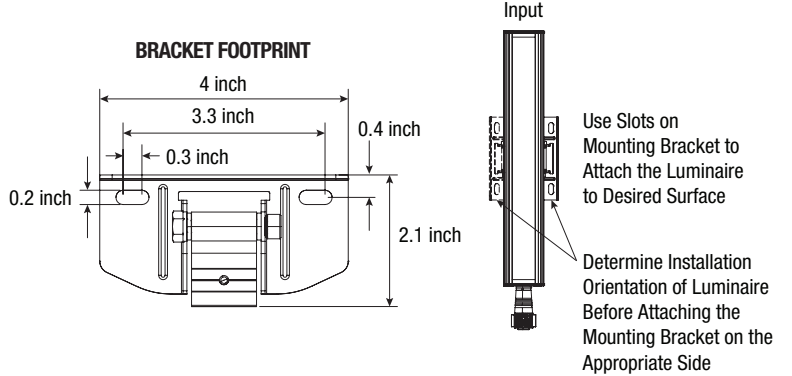
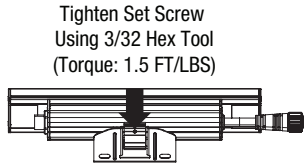
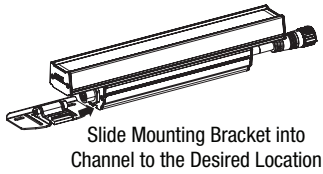

| CANTILEVER ARM — CA3 | |
|----------------------|------------|
| Bracket Part Number | Length (A) |
| CA3-6 | 6 inch |
| CA3-12 | 12 inch |
| CA3-18 | 18 inch |

| CANTILEVER ARM — CA3 (Quantity / Luminaire) | |
|---|---------------------------|
| Luminaire | Minimum Required Quantity |
| 1 FT | 1 |
| 4 FT | 2 |

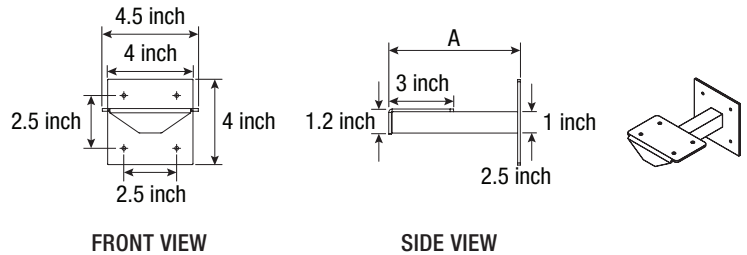

| Model | (A) Arm Length | (B) Mounting Height | (C) Mounting Width | (D) Bracket Plate Length | (E) Bracket Plate Width |
|--------|----------------|---------------------|--------------------|--------------------------|-------------------------|
| CA3-6 | 6 inch | 4 inch | 4 inch | 3 inch | 5.5 inch |
| CA3-12 | 12 inch | | | | |
| CA3-18 | 18 inch | | | | |

| LANDSCAPE SPIKE (Metal) — LS-6 | | |
|--------------------------------|-------------|-------------|
| Bracket Part Number | Above Grade | Below Grade |
| LS-6 | 6.6 inch | 12 inch |

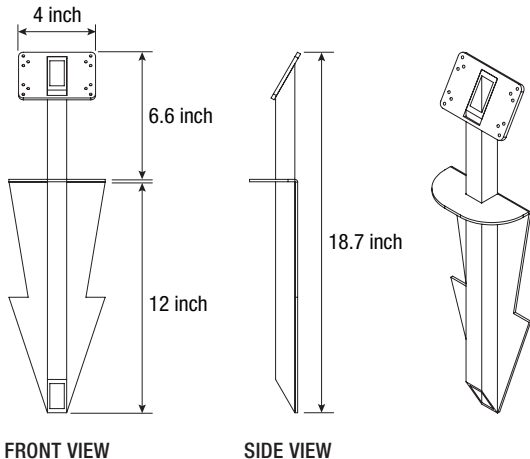

| HEAVY DUTY LANDSCAPE SPIKE — HLS | |
|----------------------------------|-----------------------|
| Bracket Part Number | Below Grade (Maximum) |
| HLS | 17.9 inch |

