

Date:	Approved:
Type:	
Luminaire:	
Project:	

eCOVELINE XL 0-10V



The **eCOVELINE XL 0-10V** is designed to work with standard 0-10V dimming system. This economical and versatile cove luminaire has two optical solutions. It's available in 1 ft, or 4 ft nominal lengths and 27K, 3K, 35K or 4K color temperatures. The housing is constructed of extruded aluminum with tooled end caps and is IP20 rated for interior use only. Features 5-pin, Plug N' Play connectors for easy installation. Integral driver provides 0-10V dimming capabilities.



QuickShip max order = 25 pcs

SPECIFICATIONS

PHYSICAL

beam spread	60°, 120°
LEDs per foot	14 per foot
mounting	Standard: surface mount bracket with (+/- 15° from center), optional: ADB2 full 180° rotation (+/- 90° from center)
housing	Extruded aluminum housing with tooled end caps
lens	Etched polycarbonate
ingress protection	Dry interior locations IP20 rated
luminaire connections	Daisy chain with male and female, 5-PIN, plug-n-play connectors
weight	1 foot (1 lbs), 4 foot (4 lbs)

PERFORMANCE

color temperature	2700K, 3000K, 3500K, 4000K
lumen output	579 lm/ft, 604 lm/ft, 628 lm/ft, 653 lm/ft
lumen maintenance	L70 ≥ 70,000 hours
operating temperature	-4°F to 104°F (-20°C to 40°C)
color consistency	3 SDCM, 84CRI, optional: 90CRI
warranty	5-Year limited warranty

ELECTRICAL

input voltage	Universal 120 - 277 VAC
power supply	Integral Class I, electronic high-power factor 94% @ 120V
interface	Dimmable to 3% full brightness, 0-10V Dimming (Standard), 5mA max, source current for max run length
certification	ETL/cETL Listed
standards	UL 1598, CSA C22.2 No. 250.0 - Class I, IES LM-79/LM-80
power consumption	1 ft @ full power (5.8W +/- 10%, 4 ft @ full power (23.2W +/- 10%)

Ordering Information

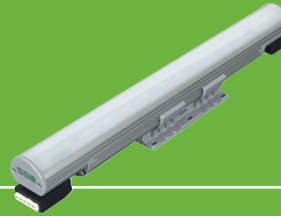



Select options next to clock symbol to qualify your order.

QuickShip max order = 25 pcs

PART NUMBERS

ECVLX10V					
-----------------	--	--	--	--	--

MODEL	LENGTH	CCT	CRI	OPTICS	OPTIONS
☑ ECVLX10V eCOVELINE XL 0-10V	☑ 1 12 in. [305 mm]	27K 2700K	☑ CRI84 84 CRI	60 60° beam	CVLL-1 coveline louver (1ft)
	☑ 4 46.8 in. [1219 mm]	☑ 3K 3000K	CRI90 90 CRI	☑ 120 120° beam	CVLL-4 coveline louver (4ft)
		☑ 35K 3500K			DVL-1 direct view lens (1ft)
		4K 4000K			DVL-4 direct view lens (4ft)
					DVL-ENDCAP direct view lens end cap (pair) <i>must have 1 pair for every DVL</i>

Cable Accessories (Indicate the quantity needed next to each item.)

REQUIRED: Starter Cable (SC6-10V) and Terminator Cap (TCAP-10V) for every run. **Maximum Run Length** = 120 feet

- ☑ _____ **SC6-10V** 6 ft. Starter Connection Cord
- ☑ _____ **TCAP-10V** Terminator Cap
- ☑ _____ **EC06-10V** 6 in. Extension Cord
- ☑ _____ **EC12-10V** 12 in. Extension Cord
- ☑ _____ **EC24-10V** 24 in. Extension Cord
- ☑ _____ **EC60-10V** 60 in. Extension Cord

Mounting Options (Indicate the quantity needed for each item.)

- ☑ _____ **ADB2** 180° Adjustable Bracket
- _____ **CA2-6** Cantilever Arm - 6"
- _____ **CA2-12** Cantilever Arm - 12"
- _____ **CA2-18** Cantilever Arm - 18"

Dimensions

eCOVELINE XL 0-10V

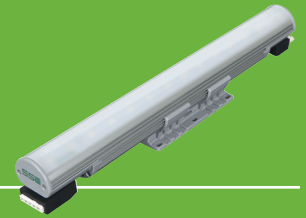

DIMENSIONS WITH STANDARD BRACKET

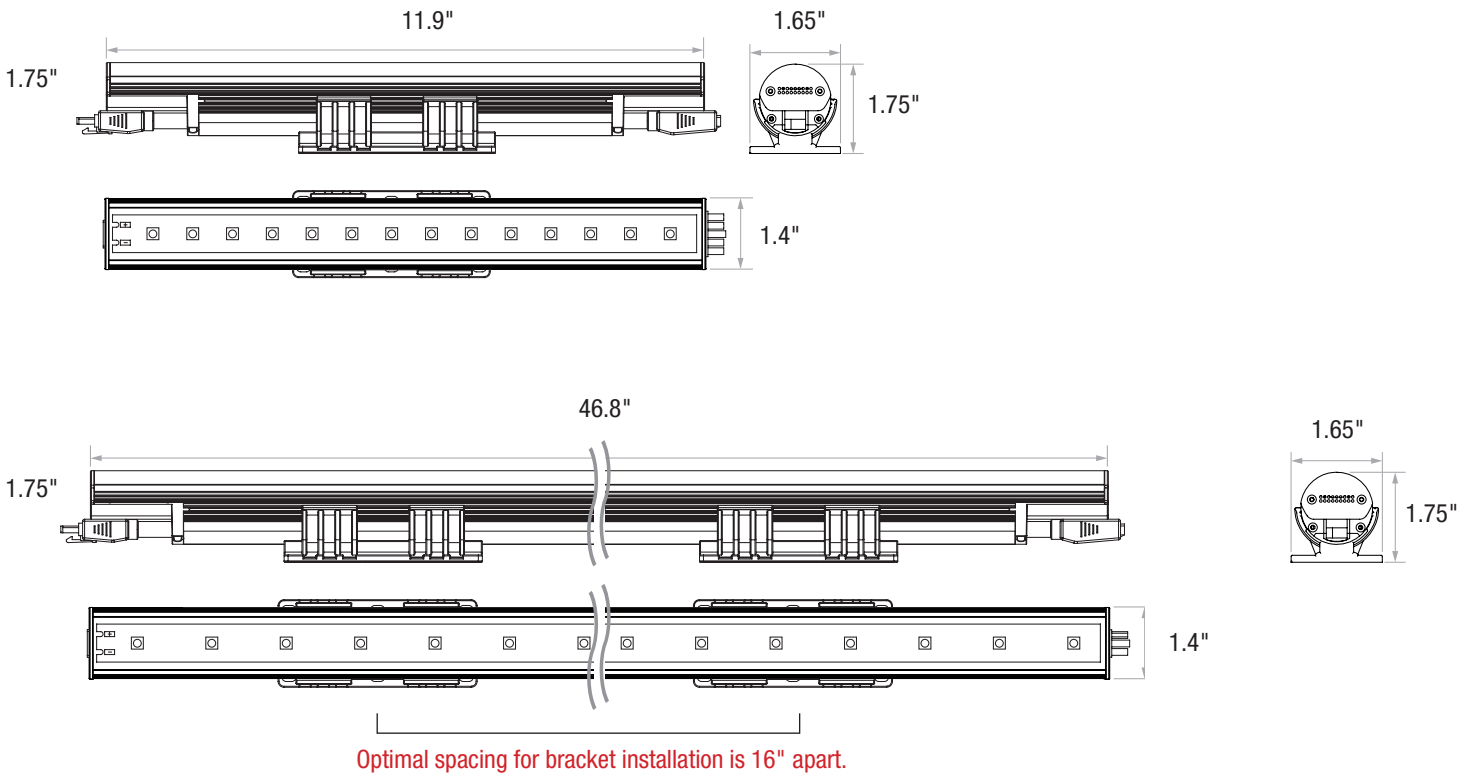

TO PREVENT VOIDING THE WARRANTY, DO NOT INSTALL BRACKETS WITHIN 2" OF THE ENDS OF LUMINAIRE.

Photometry

eCOVELINE XL 0-10V

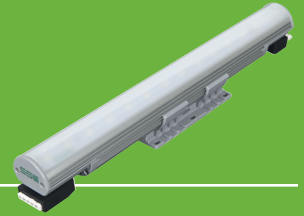

ECVLX10V 1FT 35K 120°

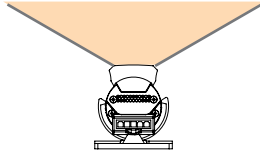

ECVLX10V 1FT 4K 60°



PERFORMANCE

Model	Delivered Lumens			
	2700K	3000K	3500K	4000K
ECVLX10V-1	579	604	628	653
ECVLX10V-4	2316	2416	2512	2612

CONTROL COMPONENT

0-10V DIMMING

Model	Description
IP710-LFZ	Leviton 0-10V Dimmer
DVSTV	Lutron Diva 0-10V Dimmer



IP710-LFZ

DVSTV

Dimmers are sold by others. FC|SSL does not recommend dimmers that have not been tested with their luminaires.

Mounting Options

eCOVELINE XL 0-10V

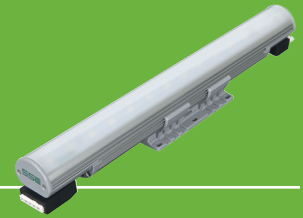

CANTILEVER ARM - Available in 3 Lengths

CA2	(A) arm length	mounting height (B)	mounting width (C)	bracket plate length (D)	bracket plate width (E)	ECVLX10V	CA2 Requirement
CA2-6	6"	4"	4"	3"	5.5"	1'	1
CA2-12	12"					4'	2
CA2-18	18"						

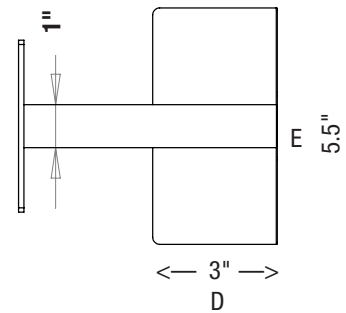
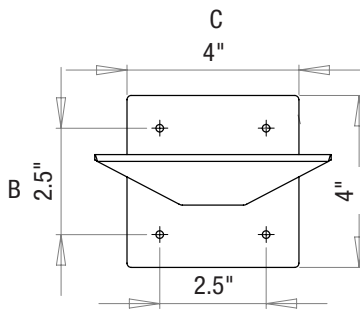
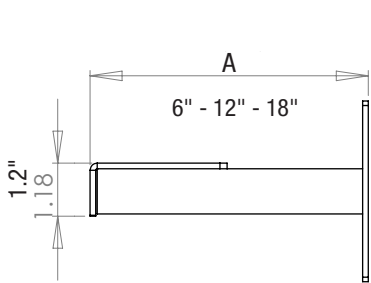

OPTIONAL ADJUSTABLE BRACKET (ADB2)

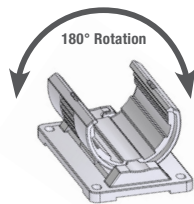
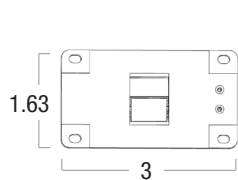

Multi-Directional.

- Adjusts +/-90°
- Mounts to horizontal or vertical surfaces
- Easy installation w/luminaire in position

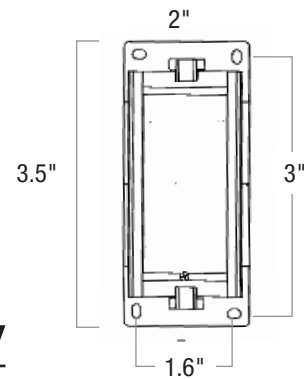
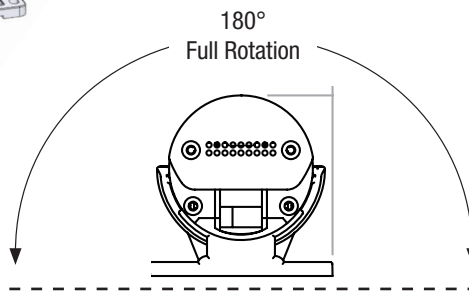
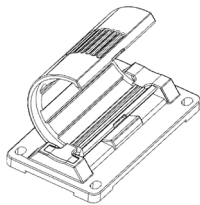

Accessories

eCOVELINE XL 0-10V

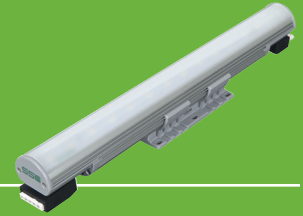

LOUVER (BLACK) - CVLL

	1FT	4FT
height	2.4"	2.4"
length	12.2"	47.2"
width	1.6"	1.6"

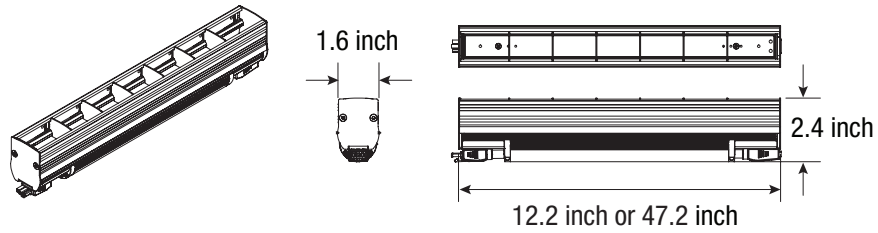

DIRECT DIFFUSER LENS - DVL

	1FT	4FT
total height	2.4"	2.4"
diffuser height	1.1"	1.1"
length	11.9"	46.8"
width	1.3"	1.3"

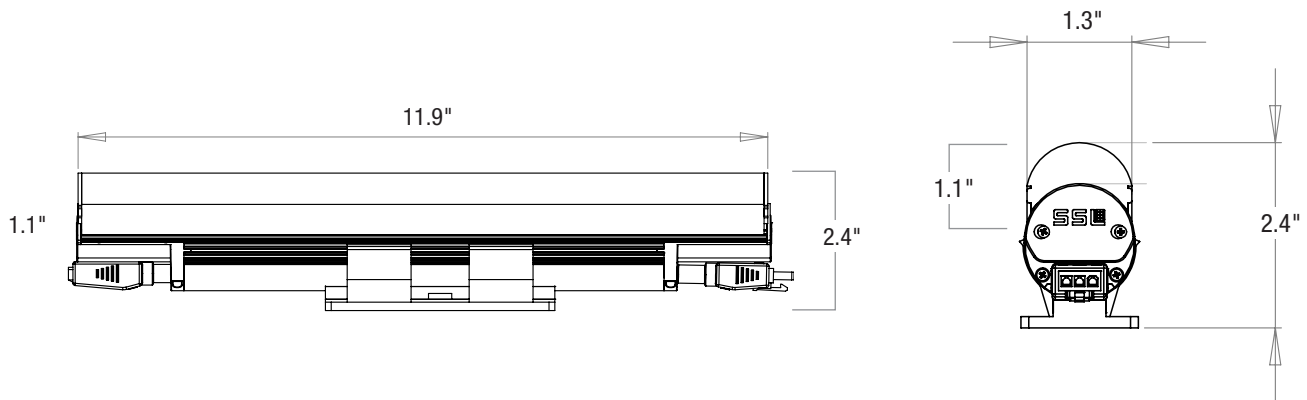

Due to continuous development and improvements, specifications are subject to change without notice.
Product use certifies agreement to Solid State Luminaires terms and conditions.

Connectivity Options

eCOVELINE XL 0-10V

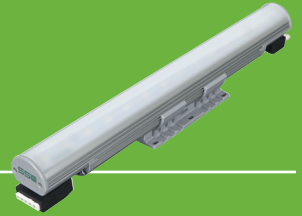

CONNECTIONS & CABLES

A:1

H

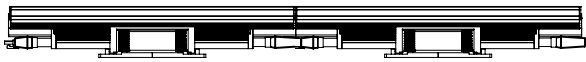

Daisy Chain Luminaires (1')

A:4

H



Daisy Chain Luminaires (4')

A1: MIN/.5" - MAX/.8" between luminaires

A4: MIN/0" - MAX/.6" between luminaires

B: SC6-10V - 6ft Starter Cord

C: EC6-10V 6 in. Extension Cord

C: EC12-10V 12 in. Extension Cord

C: EC24-10V 24 in. Extension Cord

C: EC60-10V 60 in. Extension Cord

D: TCAP-10V 1.13" Terminator Cap

B: STARTER CABLES

INSURE FIRST LUMINAIRE IS ORIENTED TO ACCEPT MALE CONNECTOR STARTER CABLE

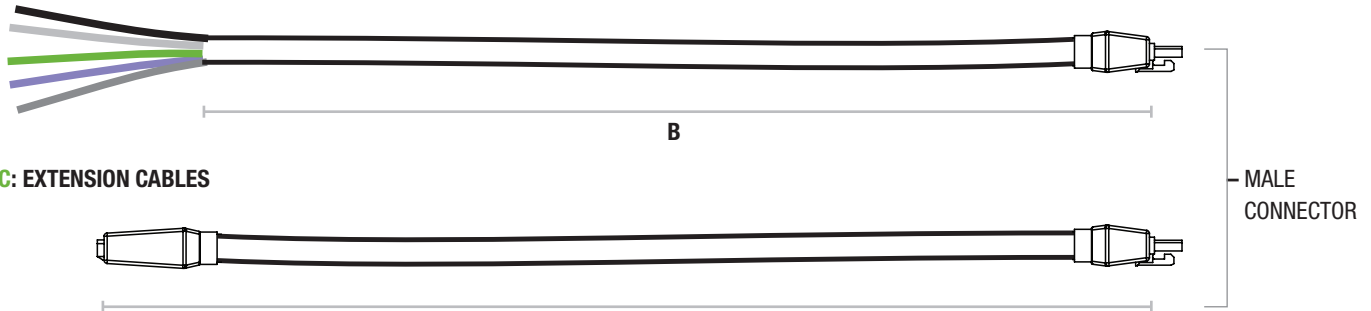

C: EXTENSION CABLES

**D: TERMINATOR CAP
(TCAP-10V)**



WIRE COLOR KEY

Black (+)	Positive
White (-)	Neutral
Green (≡)	Ground
Violet (<+)	Data (+)
Gray (<-)	Data (-)